

1 MÍNIMO ANCHO PUERTAS Y POSICIÓN PINZAS / Minimum panels width and clamp position

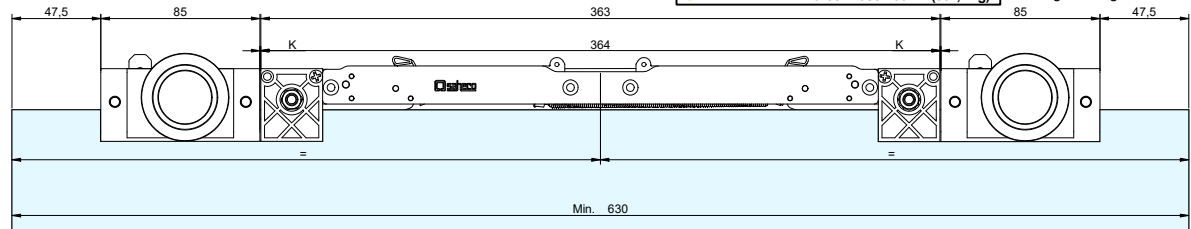

FUERZA ABRIR - Force Open = 30*2N (3*0,2 Kg)
FUERZA CERRAR - Force Close = 30*2N (3*0,2Kg)

RELACIÓN ALTO-ANCHO DEL VIDRIO: 3-1
High-wide glass ratio: 3-1

f	1		j	4				
	2			h	4			
g'	2		g''		2			
				g'''			2	

NEGRO / Black GRIS / Gray BLANCO / White

2 COLOCACIÓN SOFTBRAKE / Softbrake installation

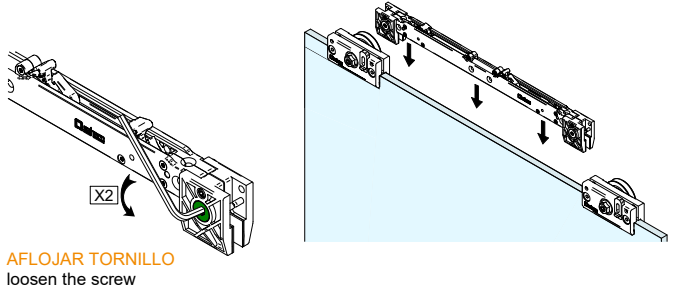

3 AJUSTAR LOS TORNILLOS / Adjust the screws

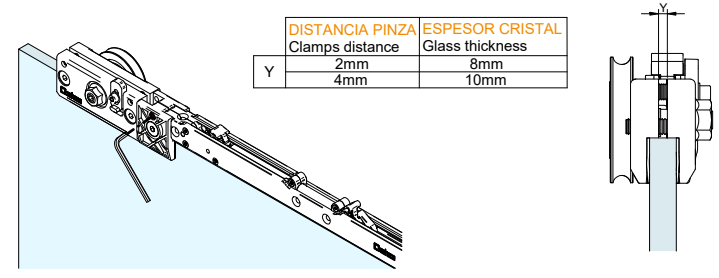

4 APRETAR LOS TORNILLOS / Tighten the screws

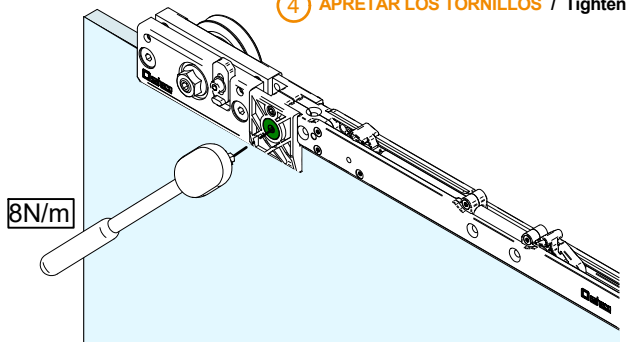

5 APRETAR LOS TORNILLOS / Tighten the screws

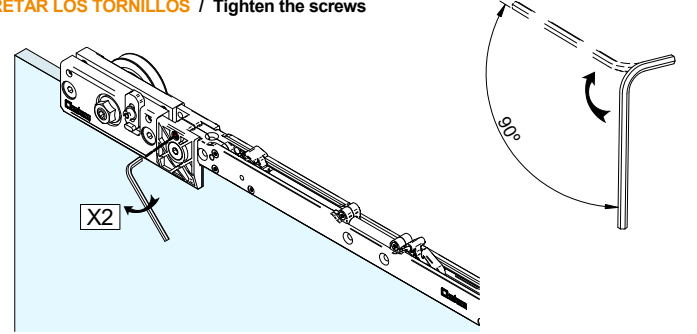

6 CARGAR EL SOFTBRAKE / Load the softbrake

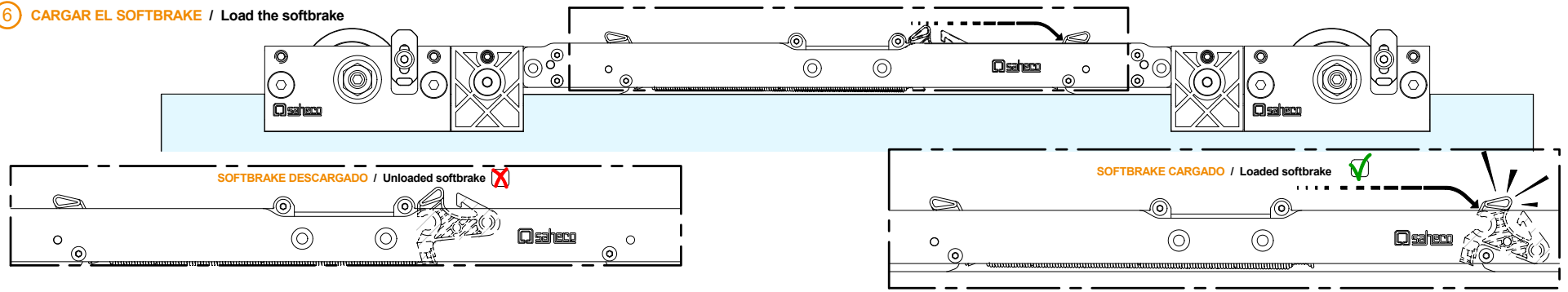

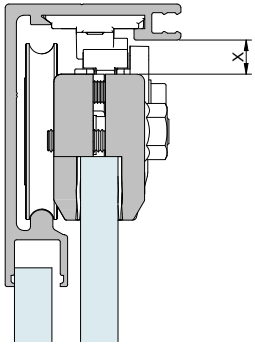

g^1		$X \geq 10,5\text{mm}$
g^2		$8,5\text{mm} < X < 10,5\text{mm}$
g^3		$X \leq 8,5\text{mm}$

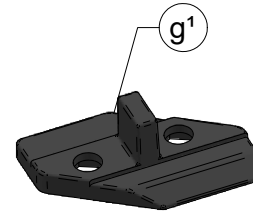

NEGRO / Black

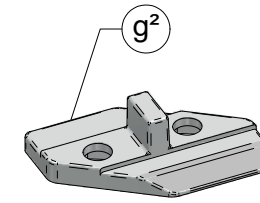

GRIS / Gray

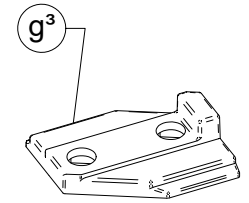

BLANCO / White

7 INSERTAR TUERCAS Y TORNILLOS / Insert nuts and screws

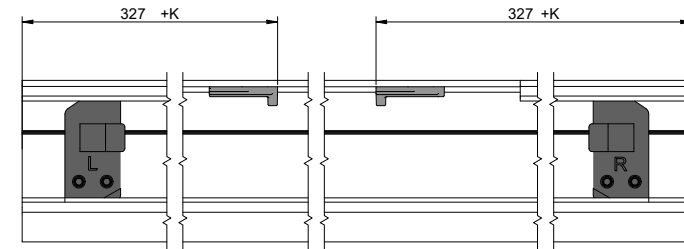
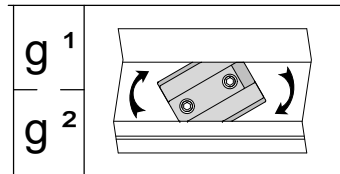
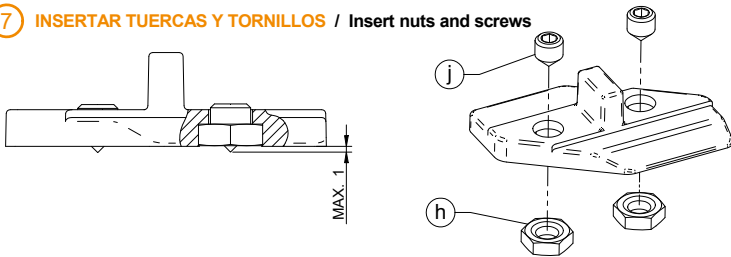

8 COLOCACIÓN DE LOS ACTIVADORES / Placing activators

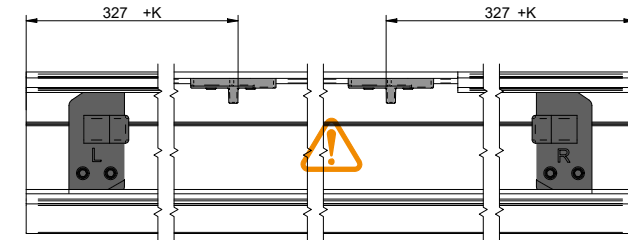
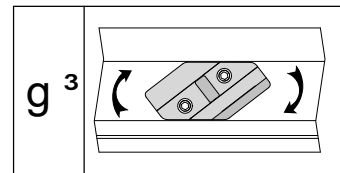

9 APRETAR LOS TORNILLOS / Strengthen the screws

